

TPV History from 1990 to Present & Future Trends

Lewis Fraas and Leonid Minkin

JX Crystals Inc, 1105 12th Ave NW Suite A2, Issaquah, WA 98027 USA
Tel: (425) 392 5237, FAX: (425) 392 7303, Lfraas@jxcrystals.com

Abstract. Herein, the history of TPV at JX Crystals over the last 15 years is described. Our focus has been on commercial application for TPV components and systems. JX Crystals began as a spin off company when the inventors of the GaSb cell left Boeing with a license to make that cell at JX Crystals. We recognized that III-V IR sensitive cells such as the GaSb cell were enabling for TPV systems. We began pilot production of GaSb cells in 1994. However, while these cells are necessary for TPV, they are not sufficient by themselves and the development of other system components has been necessary. The development of spectral control and burner and recuperator subsystems will be described here. Unfortunately, a complete TPV system still needs to be fully developed. Various R&D efforts around the world are underway targeting this objective. JX Crystals continues to supply small quantities of cells for these development efforts. Given such a TPV system, cell prices can fall dramatically with volume production.

Keywords: Photovoltaic, Thermophotovoltaics, TPV, GaSb, IR PV cell.

PACS: 84.60Jt:

HISTORICAL OVERVIEW

TPV underwent a revival in the early 1990s with the introduction of low bandgap IR sensitive III-V cells. The first of these was the GaSb cell invented in 1989 and then described in 1990 [1]. As shown in figure 1, this cell was first invented as a booster cell for use in high efficiency solar panels. The GaSb cell was made using a simple zinc diffusion process. No epitaxial coatings were required and no toxic gases were used in its fabrication. Subsequently, it was described for use in simple TPV demonstrators such as the one shown in figure 2. The GaSb cell was recognized as key for the development of TPV because it responded out to longer wavelengths than the silicon solar cell thus providing higher power densities in combination with man-made heat sources. This superior performance relative to silicon is highlighted in figure 3.

More complex ternary and quaternary IR cells followed. The reader is referred to a special review issue of Semiconductor Science and Technology [2] as well as the first 6 conference proceedings in this series for more detailed information on the history of TPV through the 1990s.

In this paper, we attempt to focus on commercial applications. This is somewhat problematic since the funding for TPV through the 1990s in the US has been primarily

from the US Army and Navy, NASA, and DARPA. In effect, this has meant that the funding relevant here has been primarily from the US Army and DARPA. The work by NASA and the Navy has been directed for applications with nuclear powered IR emitters with lower bandgap cells suited to lower temperature IR emitters. For commercial applications, this funding creates more expensive cells that produce less power. Thus, this funding moves in an opposite direction from the lower cost requirement for commercial TPV systems.

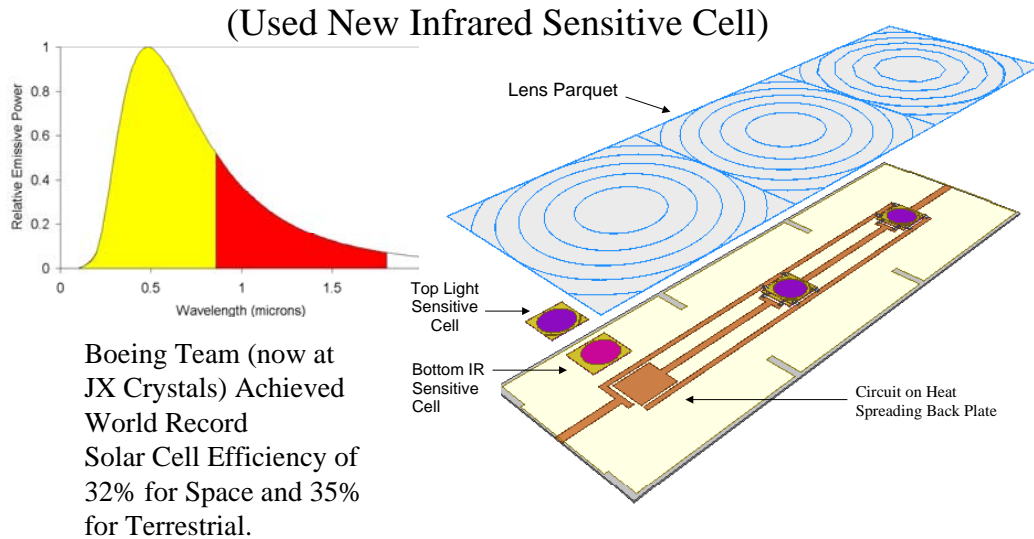
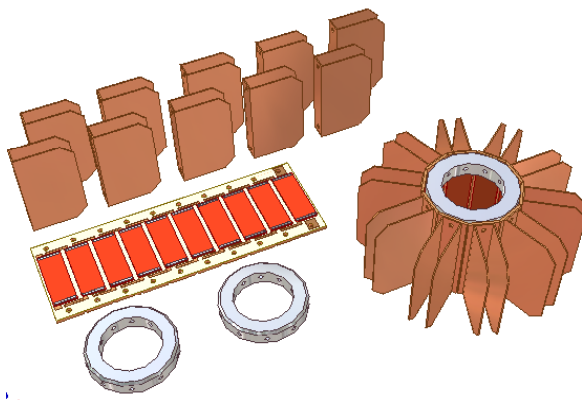

FIGURE 1. The 35% solar cell shown above was invented and demonstrated in 1989. It consisted of 2 cells stacked together. A grid was placed on the backside of a GaAs light sensitive cell and a new infrared sensitive GaSb cell was invented, demonstrated, and used as a booster cell behind the top GaAs cell.



TPV Circuit rolls up into cylinder with fins added for cooling



Oil Lamp with TPV cylinder operates radio

FIGURE 2. A kerosene lamp can be fitted with a ring of GaSb cells in a circuit in order to power a small transistor radio. This demonstrator has been functional for the last 10 years.

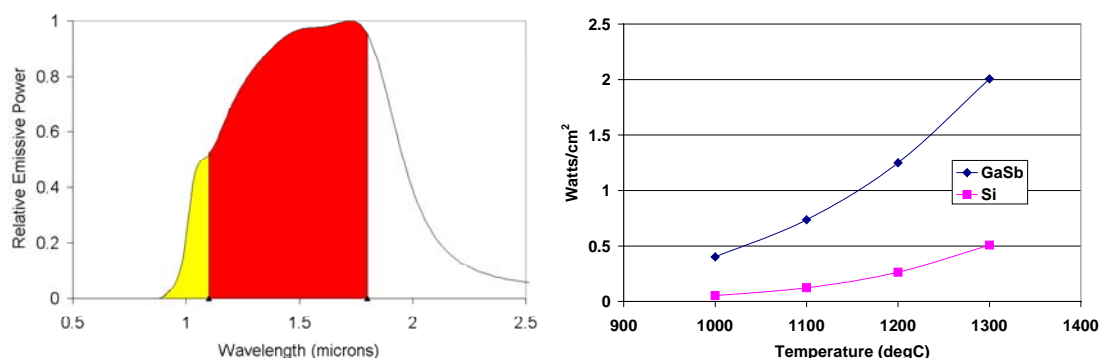

FIGURE 3. The GaSb cell is enabling for TPV because it responds further out in the infrared than traditional silicon cells do. The graph on the left is for the energy from a typical man-made heat source. The GaSb cell responds in the black and gray regions while silicon only responds in the gray region. As shown on the right, this leads to the higher power density for GaSb vs Si for various source temperatures.

The funding from DARPA and the US Army is the most relevant here as it requires the use of hydrocarbon fuels.

COMPONENT AND SYSTEM DEVELOPMENT

During the 1990s, the funding from both the Army and DARPA allowed work that was more focused on fundamental TPV system development. Given this perspective and our own internal R&D funds, we developed the Midnight Sun™ TPV stove shown in figure 4. This unit was the first commercial TPV product. It operated with a propane fuel burn rate of 27,000 BTU/h or 7.5 kW and produced about 150 W with 50 W used to operate its own blower and air circulation fans. About 20 were sold as beta-site test units from 1998 to 2001 with good customer acceptance. However, funding for manufacturing was not available and the effort was discontinued.

One of the reasons we discontinued our stove development effort was that we realized that we could make a much more efficient cylindrical TPV system. We were also motivated in this regard by the Army's need for a quiet battery charger that could run on logistic liquid hydrocarbon fuel. While the stove electrical conversion efficiency was only about 2%, we felt that with exhaust recuperation and with better spectral control [3], we could make a TPV converter with an electrical conversion efficiency of over 10%.

Another consideration derived from the liquid fuel requirement. Our cylindrical generator concept utilized a radiant tube burner where the fuel and combustion were totally contained inside the burner allowing dirtier fuels to be used without contamination of the optical elements between the emitter and the cells. The stove used a flow through emitter that was less suited to use of liquid fuels.

Because of limitation of funds as well as because of course changes with discoveries, the development of our cylindrical TPV generator has been an ongoing effort for the last 10 years.

There is a common element in both the stove and our cylindrical TPV battery charger and that is the TPV circuits. The cells are shingle mounted on circuits as can be seen in the photo at the bottom left of figure 5. This photo shows 8 circuits in a cylinder. Two of these same circuits are used in the Midnight Sun stove.

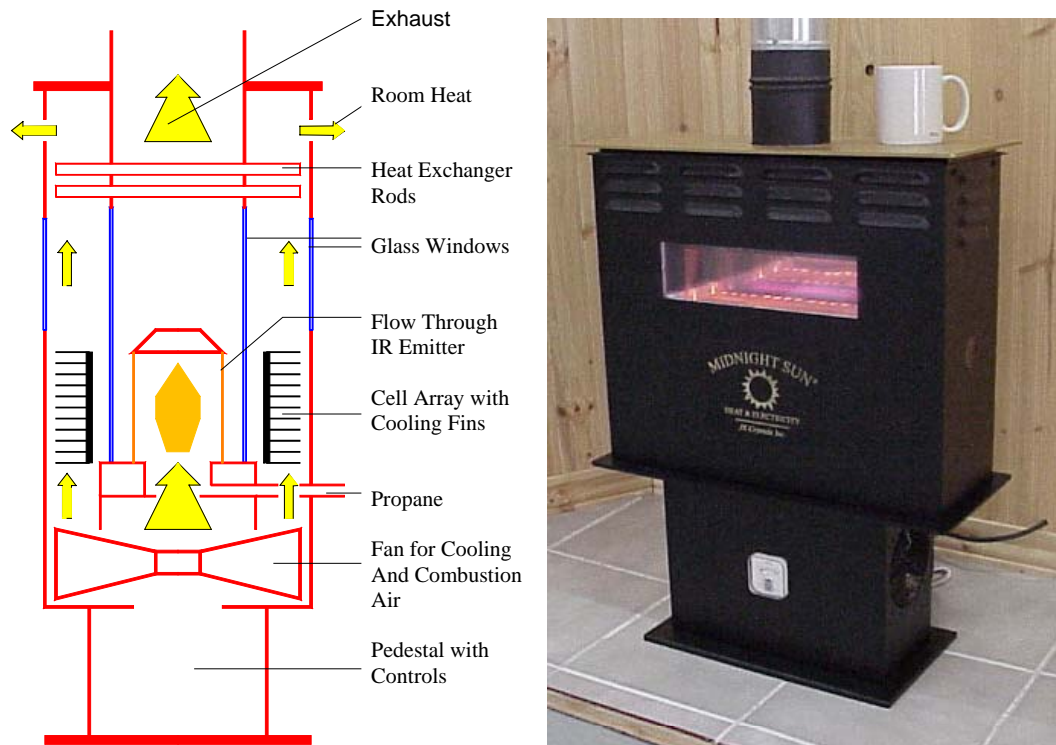
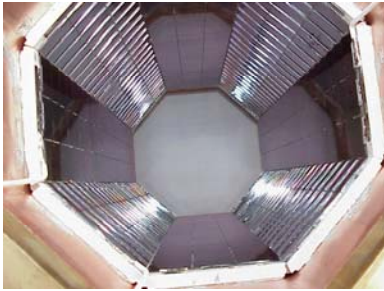
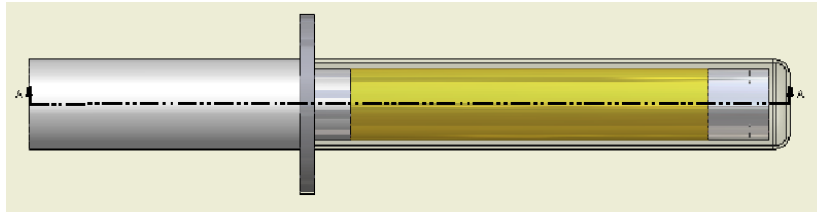

FIGURE 4. The JX Crystals Midnight Sun™ TPV stove shown here was the first commercial TPV product.

Figures 5, 6, and 7 show some of the key innovations associated with our cylindrical TPV generator development. The key idea starts with the commercially available SiC radiant tube burner. These burners are used with natural gas for industrial brazing furnaces. Referring to the top drawing in figure 5, combustion occurs in the mid-section of these radiant tubes already allowing for exhaust gas recuperation. This allows for the hot right hand portion of this tube to be the IR emitter with the left-hand colder supply end to be used for recuperation. Our innovation is to surround the hot end with a tungsten foil because tungsten has a high emittance in the cell convertible shorter wavelength band with a low emittance at long wavelength. It is just this same characteristic of tungsten that makes it useful as a light bulb filament. Unfortunately, as in the light bulb, tungsten must be operated in a vacuum or in an inert atmosphere. This can be done as is shown in figure 5. You see a combustion heated IR thermos. Good spectral control results as is seen in the graph in the bottom right of figure 5 and as is seen with the single cell test results in figure 6.

In recent years, our focus has shifted away from the fundamental TPV development issues toward the demonstration of a liquid fuel fired burner compatible with TPV. As figure 7 shows, design and reality are beginning to merge for our cylindrical TPV battery charger.



Eight circuit cylindrical water-cooled array

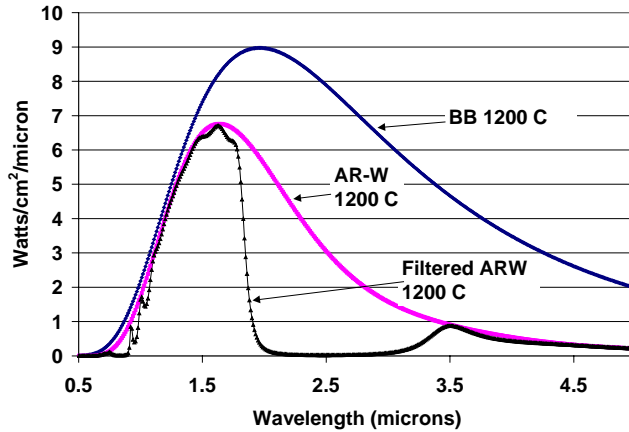

FIGURE 5. The drawing at the top shows an IR Emitter Thermos. It contains an anti-reflective coated tungsten foil for spectral control. As the graph on the bottom right shows, AR W emits much less power at long wavelengths than a blackbody at the same temperature. In combination with a filter reflecting back the mid-wavelengths, the resultant bottom curve shows that most of the radiant power is then in the cell convertible band. The picture at bottom left shows a GaSb PV array.

| | |
|---|-----------------------|
| GaSb cell electric power (referenced to emitter area) | 1.5 W/cm ² |
| Emitter temperature | 1275° C |
| Cell temperature | 25° C |
| AR/W emitter area | 469 cm ² |
| Potential PV array elec. power | 703 W |
| Chemical to radiation efficiency (measured from exhaust temp.) | 75% |
| Spectral efficiency | 74% |
| Cell efficiency | 29% |
| TPV efficiency | 21.5% |
| Fuel-to-electric efficiency | 16% |



FIGURE 6. The power output of a single GaSb cell was measured in combination with a radiant tube burner and an emitter thermos as shown in the photograph on the right. The results tabulated on the left suggest that a system electrical conversion efficiency of 16% should be achievable with a complete system.

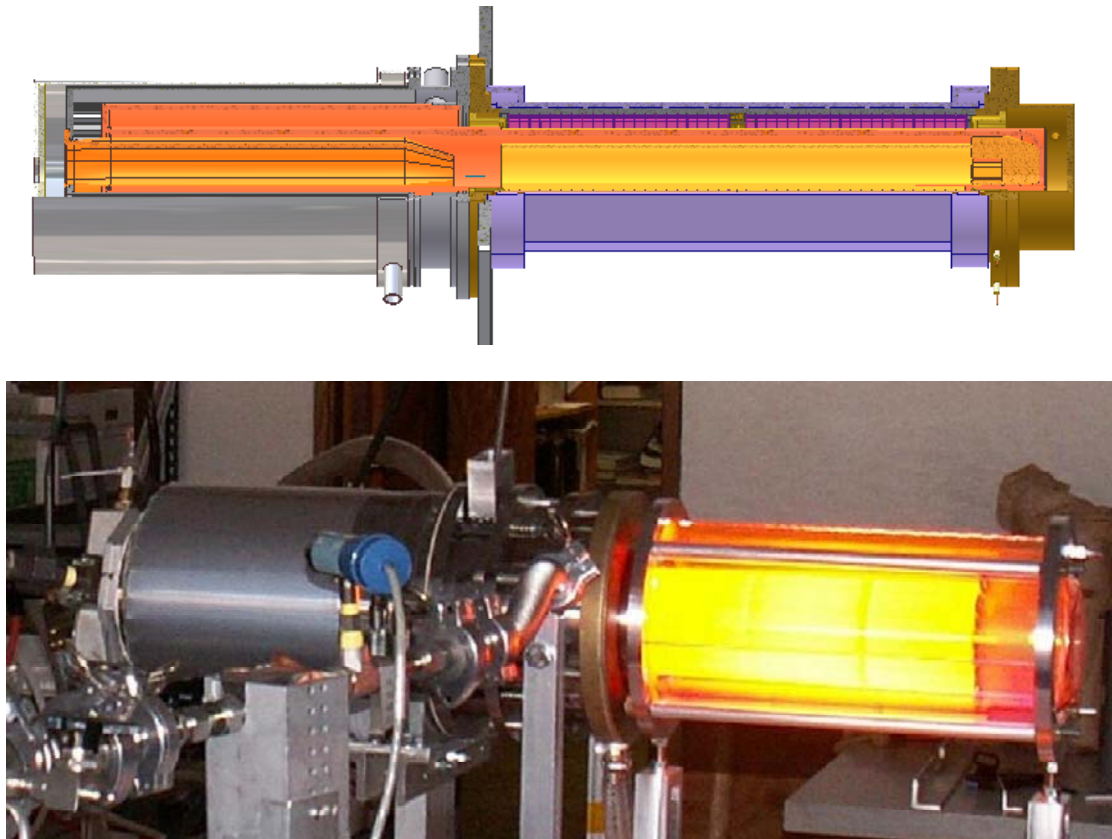

FIGURE 7. The top drawing shows the design of an efficient cylindrical TPV generator for use as a quiet battery charger for the Army. The bottom photo shows a working prototype of the burner with recuperator and emitter thermos. Unfortunately, there is no funding for developing and adding a GaSb PV array.

DISCUSSION AND CONCLUSIONS

Unfortunately, we still do not have a commercial TPV system. One of the problems is that a TPV system requires multiple players with multiple disciplines from semiconductors to ceramics to optics and burners. TPV system development will require cooperation between the multiple players in the TPV community.

Mr. Randolph Carlson has been promoting a TPV consortium. His efforts have led us to discussions with furnace companies and we now understand their perspective more clearly. This has led us to yet another TPV generator design where the emphasis is on high IR cell power density rather than system efficiency. This new 3rd system design is presented in a companion paper at this conference [4].

Meanwhile as noted in figure 1, GaSb cells can also be used in solar photovoltaic concentrator panels [5] as described in figure 8. Solar PV concentrators are also systems but the infrastructure and momentum is presently more advanced in the solar community compared with the TPV community. We at JX Crystals are hoping that these new solar PV applications will help us move our GaSb cells from pilot production into higher volume production with lower cell prices.

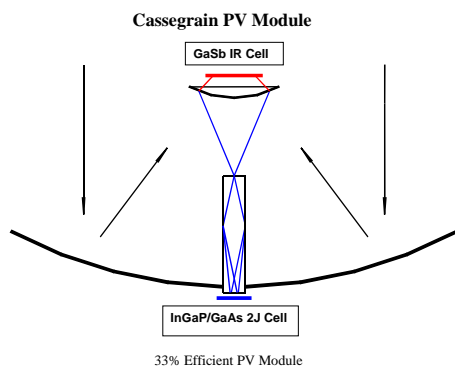

**JX Crystals Inc
Cassegrain Module**

Parts List

1. Dichroic Hyperbolic Secondary
2. Glass Window
3. Homogenizer for Dual-Junction (DJ) Cell
4. DJ Circuit
5. Homogenizer for IR Circuit
6. IR Circuit
7. Primary Mirror
8. DJ Heat Sink / Base
9. DJ Homogenizer Support
10. IR Circuit Can / Heat Sink
11. Side Wall

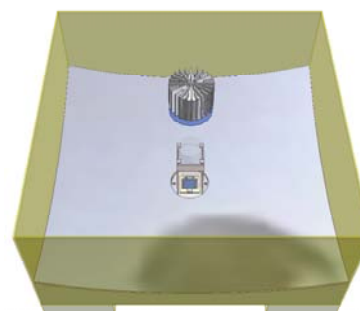

Performance Summary

| | Packaged Cells at STC | Projected STC with 90% Optical Effic | Measure at Operate Temp (April 28) | Measure Module at STC (April 28) |
|----------------|-----------------------|--------------------------------------|------------------------------------|----------------------------------|
| DJ Cell Power | 17.4 W | 15.7 W | 14.4 W | 15.1 W |
| DJ Cell Effic. | 31.5% | 28.4% | 26.1% | 27.3% |
| IR Cell Power | 3.64 W | 3.28 W | 2.6 W | 3.1 W |
| IR Cell Effic. | 6.6% | 5.9% | 4.7% | 5.6% |
| Sum Power | 21 W | 19 W | 17 W | 18.7 W |
| Sum Effic. | 38.1% | 34.3% | 30.8% | 32.9% |

NIP DNI = 0.92; Area = 600 cm²; Input Power = 55.2 W

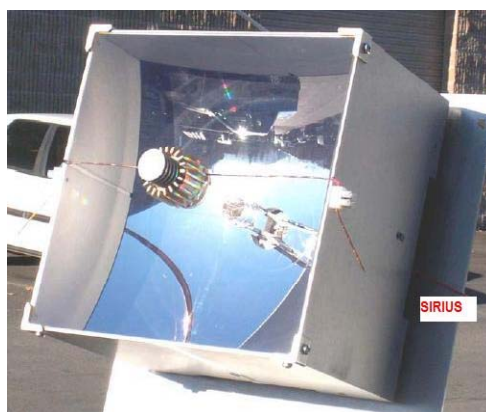

FIGURE 8. Our GaSb cells are also used in our 31% efficient Cassegrain solar concentrator modules.

REFERENCES

1. Lewis Fraas, James Avery, James Gee, Keith Emery, et. al., "Over 35% Efficient GaAs/GaSb Stacked Concentrator Cell Assemblies for Terrestrial Applications", 21st IEEE PV Specialist Conference, p. 190 (1990).
2. L. M. Fraas et al, "Thermophotovoltaic Furnace-Generator for the Home Using Low Bandgap GaSb Cells", Semiconductor Science & Technology. **18**, p. S247 (2003).
3. L. M. Fraas et al, "Thermophotovoltaic System Configurations and Spectral Control", Semiconductor Science Technology. **18**, p. S165 (2003).
4. R. Carlson and L. Fraas, companion paper at this TPV7 conference.
5. Lewis M. Fraas, **Path to Affordable Solar Electric Power & The 35% Efficient Solar Cell**, Published by JX Crystals Inc (2005). Available from www.Amazon.com or www.jxcrystals.com.