

IR to DC Converter Circuits

2x54 cells for 36 W
& 2x72 cells for 50 W

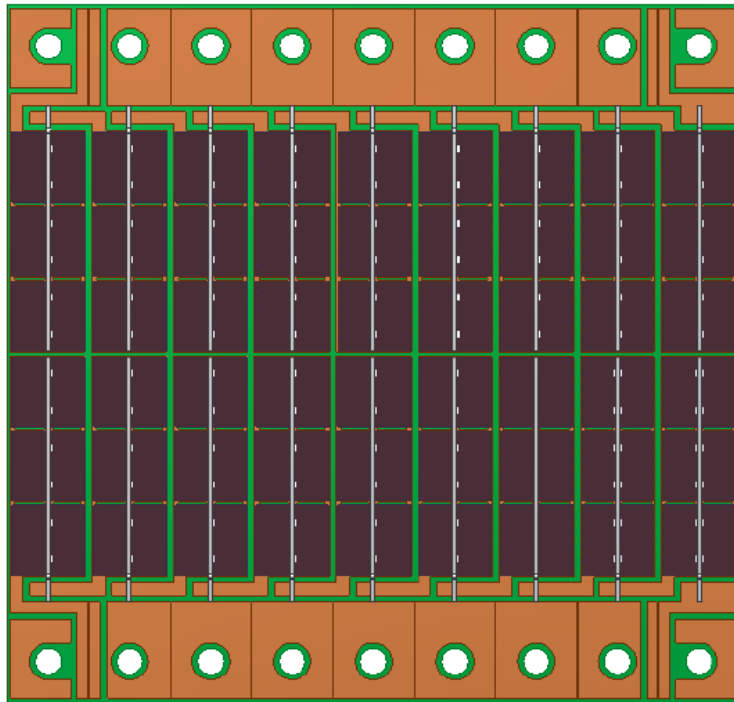

3 A & 6 V = 18 W
8.8 cm x 8.4 cm
3.5 in x 3.3 in

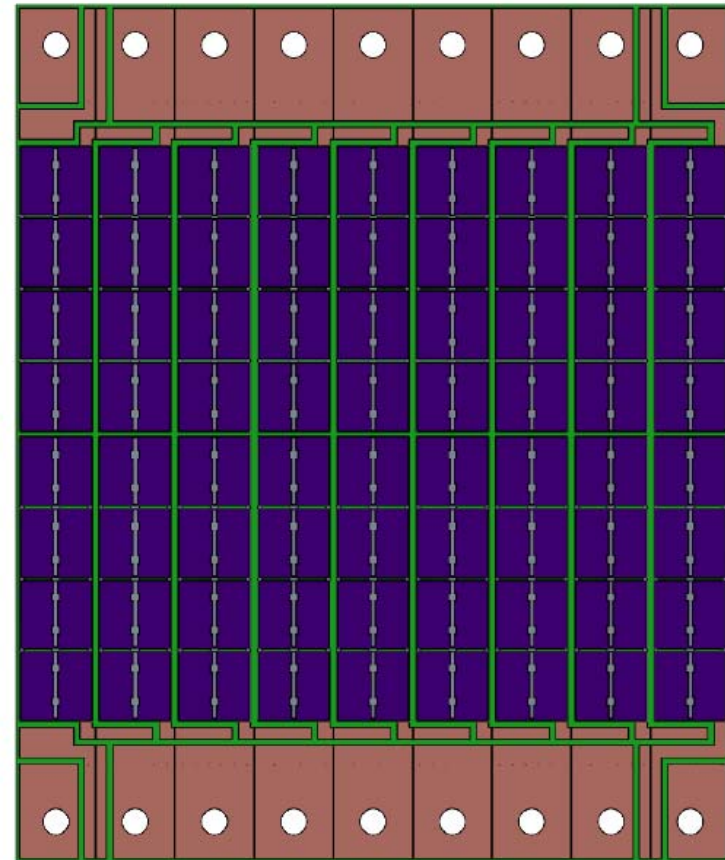



Scales from flat to cylindrical & from 50 W to 100 W

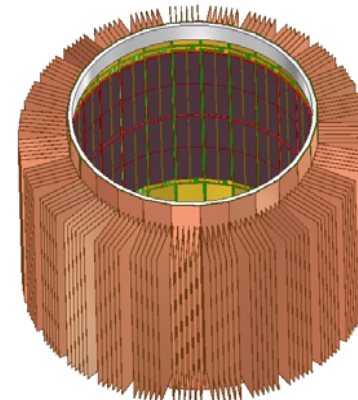
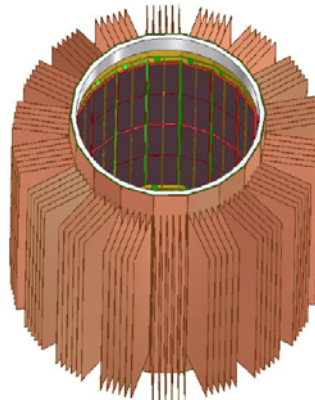
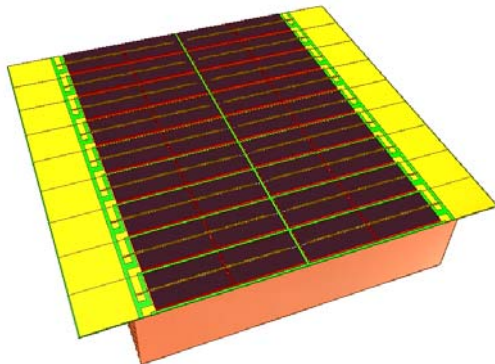
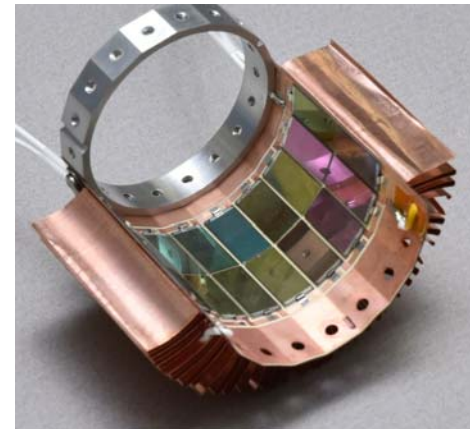
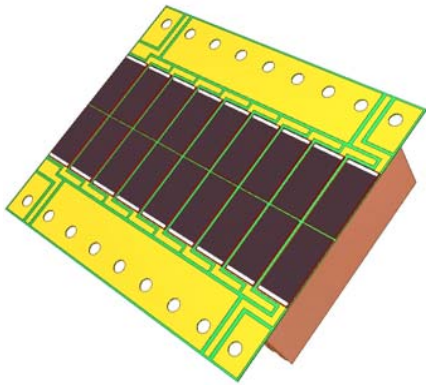



Functional stand alone TPV power supply.

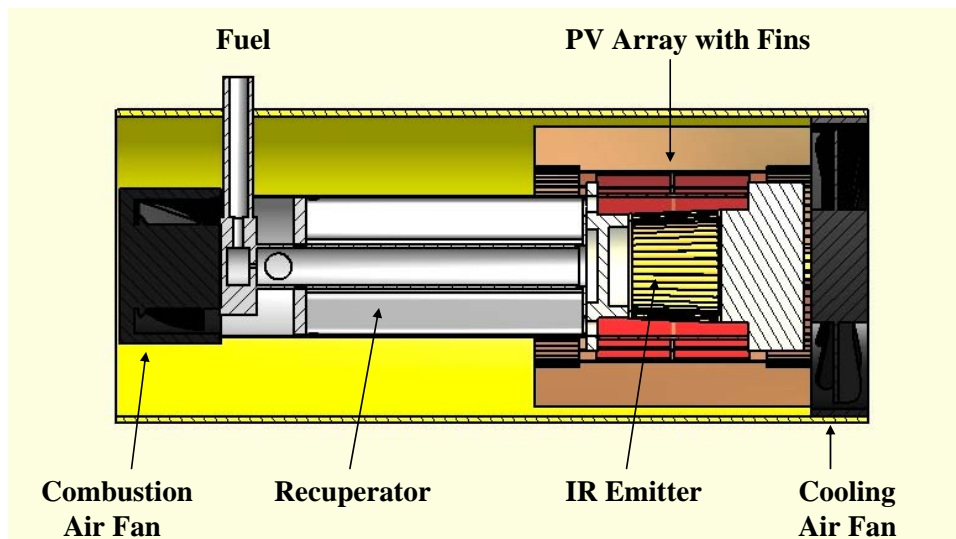

Cross section of TPV generator cylinder.



4x100 W = 400 W TPV
11"x11"x14"

